

Date \_\_\_\_\_  
 AVFI Sales REP \_\_\_\_\_  
 Customer Signature \_\_\_\_\_

Quote No. \_\_\_\_\_  
 Customer No. \_\_\_\_\_  
 AVFI No. \_\_\_\_\_

Office Use Only









To generate your order form, please refer to the information provided below to insert the alphabetic and/or numeric code in the respective category boxes. Please note that without this filled out Order Form, your purchase **cannot** be processed.



1 Product Model	2 Finish	3 Chargeable Accessories	4 Custom Cutouts
<b>MOD2965-00</b>			



**2** Choose Product Finish

Standard Finishes (Ships within 1-15 business days)

							
MCT	HCT	CLT	AST	AMT	SBT	WLT	SST

		
EBT	SGT	CWT

- 3** Chargeable Accessories (Check all that apply)
- Code **0** No Accessories
- \* Code **EF** CHGQIB Wireless Charging Station Black Qty: \_\_\_\_\_
  - Code **K1** C900S Single Monitor Arm Qty: \_\_\_\_\_
  - Code **K2** C900D Dual Monitor Arm Qty: \_\_\_\_\_
  - \* Code **P2** PCH730 PC Holder (Mini tower only) Qty: \_\_\_\_\_
  - \* Code **K3** PLM1022 LCD Monitor Mount Qty: \_\_\_\_\_
  - \* Code **D3** FM3 Countdown Timer and Clock Qty: \_\_\_\_\_
  - \* Code **D2** LIGHT-18 Adjustable Gooseneck Light Qty: \_\_\_\_\_
  - \* Code **E3** CUB3 Round Cable Well Qty: \_\_\_\_\_
  - \* Code **E5** CUB5 Black Round Cable Well Qty: \_\_\_\_\_
  - \* Code **E6** CUB5 Silver Round Cable Well Qty: \_\_\_\_\_
  - \* Code **E8** CUB8 Table Top Cable Well Qty: \_\_\_\_\_
  - \* Code **EA** CUB4S Silver Power Panel Qty: \_\_\_\_\_
  - \* Code **EB** CUB4B Round Cable Well Qty: \_\_\_\_\_
  - \* Code **EJ** CUB22 Black 3 Module Panel Qty: \_\_\_\_\_
  - \* Code **EK** CUBM3 3 Module Power & Data Panel Qty: \_\_\_\_\_
  - \* Code **EL** CUBM4 4 Module Power & Data Panel Qty: \_\_\_\_\_
  - \* Code **M10** FWM100 VESA Mounting Bracket Qty: \_\_\_\_\_
  - Code **P10** 50CAS Easy Maneuvering Casters Qty: \_\_\_\_\_
  - Code **E1** PB 6 Outlet Power Bar Qty: \_\_\_\_\_
  - Code **B1** 9031-1 1U Utility Metal Shelf Qty: \_\_\_\_\_
  - Code **B2** 9031-2 2U Utility Metal Shelf Qty: \_\_\_\_\_
  - Code **B3** 9031-3 3U Utility Metal Shelf Qty: \_\_\_\_\_
  - Code **B4** 9041 Sliding Metal Shelf Qty: \_\_\_\_\_

- 3** Chargeable Accessories (Check all that apply)
- |   |            |
|---|------------|
| Code <b>B5</b> 9052-2 2U Sliding Metal Drawer             | Qty: _____ |
| Code <b>B6</b> 9052-3 3U Sliding Metal Drawer             | Qty: _____ |
| Code <b>J1</b> 9107 Lacing Bar                            | Qty: _____ |
| Code <b>D4</b> FAN Quiet Cooling Fan                      | Qty: _____ |
| Code <b>X9</b> MODU-EXT Door extenders for 23" rack depth | Qty: _____ |
| Code  | Qty: _____ |
| Code  | Qty: _____ |
| Code  | Qty: _____ |
| Code  | Qty: _____ |
| Code  | Qty: _____ |
| Code  | Qty: _____ |
| Code  | Qty: _____ |
| Code  | Qty: _____ |
| Code  | Qty: _____ |
| Code  | Qty: _____ |
| Code  | Qty: _____ |
| Code  | Qty: _____ |
| Code  | Qty: _____ |
| Code  | Qty: _____ |
| Code  | Qty: _____ |
| Code  | Qty: _____ |
| * Cutout Required (Extra Charges will apply)              |            |
| § Only on Flat Cutout                                     |            |

Date \_\_\_\_\_  
AVFI Sales REP \_\_\_\_\_  
Customer Signature \_\_\_\_\_

Quote No. \_\_\_\_\_  
Customer No. \_\_\_\_\_  
AVFI No. \_\_\_\_\_

OFFICE USE ONLY

Office Use Only

Comments (Please use this section to provide additional information)

---

---

---

---

---

---

---

---

---

---

Notes

**CAD Drawings/Symbols**

CAD drawings are available by request at sales@vegroun.net

**Custom Cutouts**

Estimated lead time within 20 business days from receipt of P.O. and signed drawings.

**Customizations**

Modifications to design such as shape and/or size variations have to be quoted on a per case basis and are applicable for quantities of 10+ only.

Please indicate custom cutout location on the drawing(s) below

4 Custom Cutout Option (Extra charges will apply)

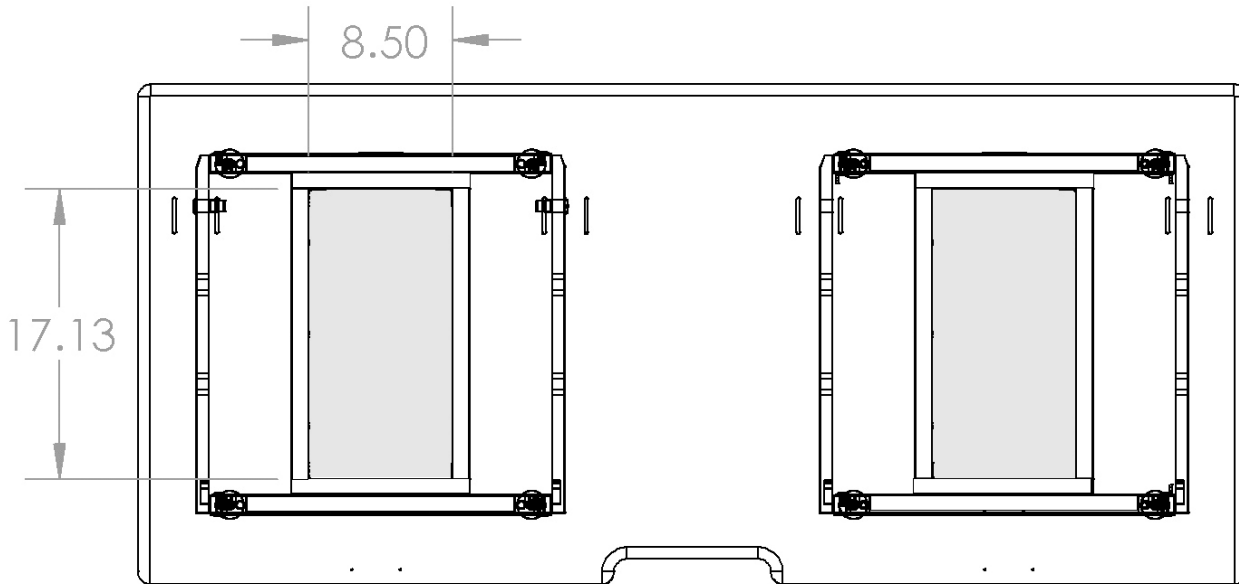

Code **CO** No Custom Cutout

Code **CC** Custom Cutout (Specify on Cutout Area Above)

■ Cutout Area - Work Surface